

# V400m Terminal & Base

## *Installation Guide*



V400m Terminal & Base Installation Guide  
© 2021 Verifone, Inc.

All rights reserved. No part of the contents of this document may be reproduced or transmitted in any form without the written permission of Verifone, Inc.

The information contained in this document is subject to change without notice. Although Verifone has attempted to ensure the accuracy of the contents of this document, this document may include errors or omissions. The examples and sample programs are for illustration only and may not be suited for your purpose. You should verify the applicability of any example or sample program before placing the software into productive use. This document, including without limitation the examples and software programs, is supplied "As-Is."

Verifone and the Verifone logo are registered trademarks of Verifone. Other brand names or trademarks associated with Verifone's products and services are trademarks of Verifone, Inc.

All other brand names and trademarks appearing in this manual are the property of their respective holders.

Product Warranty

For product warranty information, visit <http://www.verifone.com/terms>.

**Comments?** Please e-mail all comments on this document to your local Verifone Support Team.

Verifone Inc.  
1-800-Verifone  
[www.verifone.com](http://www.verifone.com)

Verifone Part Number: DOC475-003-EN-A, Revision A01



# CONTENTS

- PREFACE** . . . . . 5
  - Audience . . . . . 5
  - Organization . . . . . 5
  - Related Documentation . . . . . 5
  - Guide Conventions . . . . . 6
    - Acronym Definitions . . . . . 6
  
- CHAPTER 1**  
**Overview**
  - V400m . . . . . 9
    - Front Functions . . . . . 10
    - Back Functions . . . . . 10
  - V400m Bases . . . . . 11
    - V400m Charging Base . . . . . 11
    - V400m Full-Function Base . . . . . 11
  - Features and Benefits . . . . . 12
    - Exceptional Ease of Use and Ergonomics . . . . . 12
    - Critical Security Protection . . . . . 13
  
- CHAPTER 2**  
**Setup**
  - Selecting Location . . . . . 15
    - Environmental Factors . . . . . 15
    - Electrical Considerations . . . . . 16
    - Contactless Considerations . . . . . 16
  - PIN Protection Guidelines . . . . . 16
  - Unpacking Shipping Carton . . . . . 17
  - Installing MSAM, SIM and Micro SD Cards . . . . . 17
    - Accessing Card Compartments . . . . . 17
    - Changing or Installing an MSAM Card . . . . . 18
    - Changing or Installing a SIM Card . . . . . 19
    - Changing or Installing a Micro SD Card . . . . . 20
  - Loading Printer Paper . . . . . 21
  - Power Supply . . . . . 22
  - Cable Connections . . . . . 23
    - Cable Connections Using the FF Base . . . . . 23
  - Smart Card Reader . . . . . 23
  - Magnetic Stripe Card Reader . . . . . 24
  - Contactless Transaction . . . . . 25
  - Optional Accessories . . . . . 26
    - FF Base . . . . . 26
    - Charging Base . . . . . 26
  - Periodic Inspection . . . . . 27
  
- CHAPTER 3**  
**Specifications**
  - V400m Terminal . . . . . 29
    - Unit Power Requirements . . . . . 29
    - Temperature . . . . . 29

Humidity . . . . .	29
External Dimensions . . . . .	29
Weight . . . . .	29
Processor . . . . .	29
Memory . . . . .	29
SD Memory . . . . .	30
Security . . . . .	30
Display . . . . .	30
SAM Card Reader . . . . .	30
CTLS Reader . . . . .	30
Magnetic Card Reader . . . . .	30
Primary Smart Card . . . . .	30
Speaker . . . . .	30
Communication . . . . .	31
Battery Pack . . . . .	31
Power Pack . . . . .	31
Integrated Printer . . . . .	31
Security . . . . .	31
V400m Bases . . . . .	32
Unit Power Requirements . . . . .	32
Temperature . . . . .	32
Humidity . . . . .	32
Communication . . . . .	32
Security . . . . .	32

**CHAPTER 4**  
**Troubleshooting**  
**Guidelines**

Display Panel Does Not Work . . . . .	33
Keypad Does Not Respond . . . . .	33
Transactions Fail to Process . . . . .	33

**CHAPTER 5**  
**Service and Support**

Maintenance and Cleaning . . . . .	35
Service Returns . . . . .	35
Accessories and Documentation . . . . .	37
Cables . . . . .	37
Base . . . . .	37
Power Supply . . . . .	37
Cleaning Kit . . . . .	37
Documentation . . . . .	38
Caution and Warning Messages . . . . .	39



This guide is the primary source of information for setting up and installing the V400m and V400m Bases.

## Audience

This guide provides simple descriptions of the product features and information for installing and configuring V400m terminals and the V400m Charging and Full-Function Bases.

## Organization

This guide is organized as follows:

[Chapter 1, Overview](#). Provides an overview of V400m Terminal & Base.

[Chapter 2, Setup](#). Explains how to set up and install the V400m Terminal & Base and establish connections with other devices.

[Chapter 3, Specifications](#). Discusses the power requirements and dimensions of the V400m Terminal & Base.

[Chapter 4, Troubleshooting Guidelines](#). Provides troubleshooting tips.

[Chapter 5, Service and Support](#). Provides information on contacting your Verifone service provider, ordering accessories or documentation from Verifone, and maintaining the V400m Terminal & Base.

[Appendix A, Caution and Warning Messages](#). Shows the UL/cUL certification-compliant translations of all Warning and Caution messages in this installation guide.

## Related Documentation

To learn more about the V400m and V400m Bases, please refer to the following documents and their associated Verifone Part Numbers (VPN):



<i>V400m Plus 3G Certifications and Regulations</i>	DOC475-001-EN
<i>V400m Quick Installation Guide</i>	DOC475-002-EN
<i>V400m Reference Guide</i>	DOC475-004-EN
<i>V400m B-Charging Quick Installation Guide</i>	DOC475-006-EN
<i>V400m B-FF Quick Installation Guide</i>	DOC475-007-EN
<i>V400m Base C and FF Certifications &amp; Regulations Sheet</i>	DOC475-011-EN
<i>V400m Plus 4G Certifications and Regulations</i>	DOC475-031-EN

## Guide Conventions

Please refer to the following document conventions for quickly identifying special formatting.

Table 1 describes these conventions and provides examples of their use.

**Table 1 Document Conventions**

Convention	Meaning	Example
Blue	Text in blue indicates terms that are cross-references.	See <a href="#">Guide Conventions</a> .
<i>Italics</i>	Italic typeface indicates book titles or emphasis.	You <i>must</i> not use this unit underwater.
<b>NOTE</b> 	The pencil icon is used to highlight important information.	RS-232-type devices do not work on the V400m Terminal & Base communication port.
<b>CAUTION</b> 	The caution symbol indicates hardware or software failure, or loss of data.	The unit is not waterproof or dustproof and is intended for indoor use only.
<b>WARNING</b> 	The lightning symbol is used as a warning when bodily injury might occur.	Due to risk of shock do not use the unit near water.

## Acronym Definitions

Please refer to Table 2 for the acronyms used in this manual.

**Table 2 Acronym Definitions**

Acronym	Definitions
3DES	Triple Data Encryption Algorithm
AC	Alternating Current
ANSI	American National Standards Institute
cUL	Underwriters' Laboratories of Canada
DC	Direct Current
DUKPT	Derived Unique Key Per Transaction Method as defined in the VISA's <i>POS Equipment Requirement: PIN processing and Data Authentication</i> , International Version 1.0, August 1988
ECR	Electronic Cash Register
EMV	Europay, MasterCard, and Visa
HSPA	High Speed Packet Access
ISO	International Organization for Standardization
MRA	Merchandise Return Authorization
MSAM	Multiple Secure Access Module
LAN	Local Area Network
LCD	Liquid Crystal Display
LED	Light-Emitting Diode

**Table 2**      **Acronym Definitions** (continued)

Acronym	Definitions
LTE	Long-Term Evolution
PED	PIN Entry Device
PIN	Personal Identification Number
POS	Point-of-Sale
RS-232	Recommend Standard number 232
SAM	Secure Access Module
SD	Secure Digital
UL	Underwriters Laboratories
USB	Universal Serial Bus
VPN	Verifone Part Number







### Overview

This chapter describes the features of the V400m and the V400m Bases.

#### V400m

The V400m is Verifone’s next generation integrated retail PINpad device. Its touchscreen functionality and sophisticated design is perfect for high-end retail establishments.

The V400m is a consumer-facing handheld device. The product’s design is equally appealing as a handheld PINpad and robust enough to look and function appropriately in a fixed mount setting.

The V400m can utilize over-the-air connectivity, facilitating mobile telephony technology for sending and receiving data, using existing operator-provided 3G or 4G infrastructure:

- V400m Plus 3G - provides third-generation High Speed Packet Access (HSPA) connectivity.
- V400m Plus 4G - provides fourth-generation Long Term Evolution (LTE) connectivity.

This guide provides an introduction and basic setup procedures for both 3G and 4G terminals, and will indicate where instructions vary for different models.

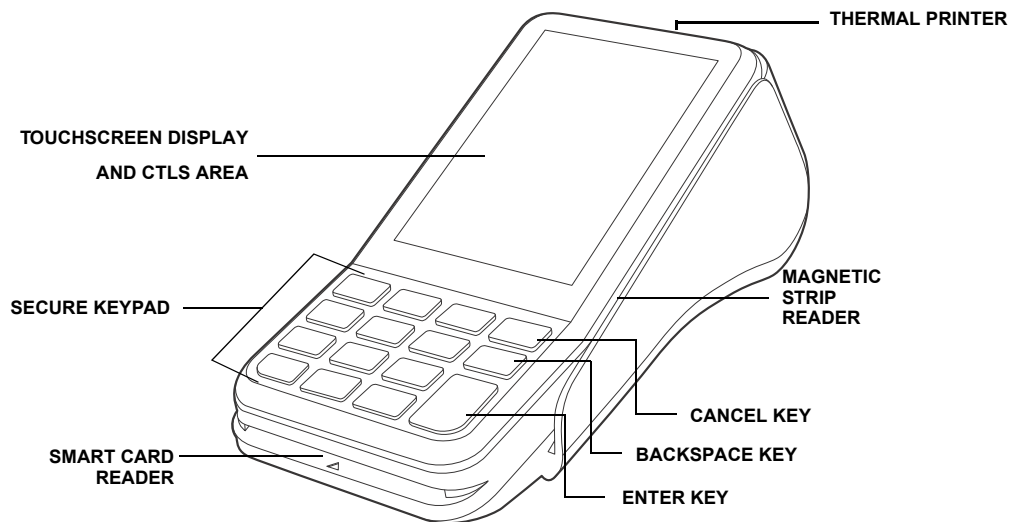
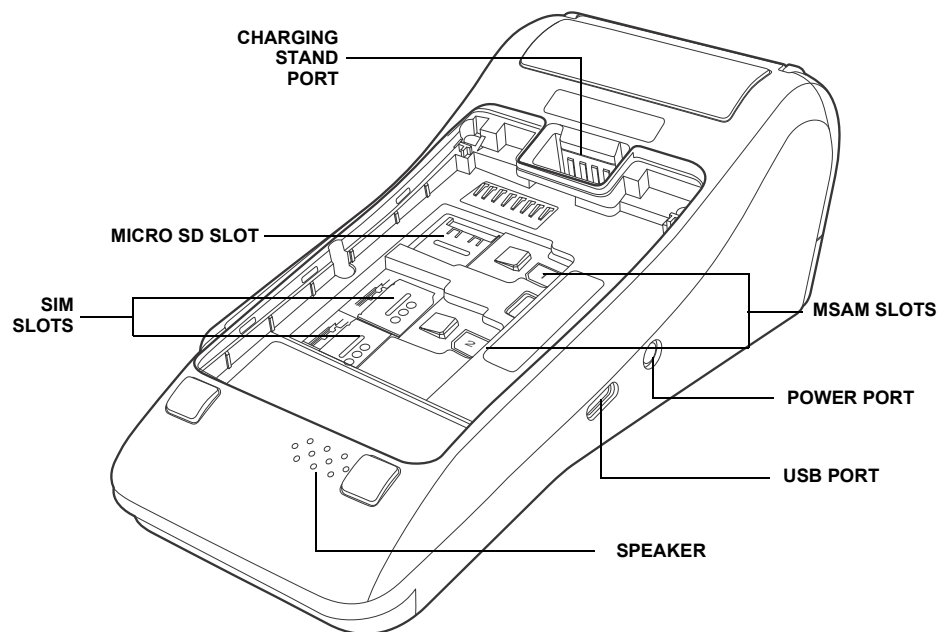

**Figure 1** V400m Front

**Front Functions** The V400m includes the following features:

- Capacitive touch **LCD display** and **CTLS** tap area
- **Smart card** reader
- **Magnetic card** reader
- Integrated thermal **printer**
- Secure keypad supporting 4x4 matrix containing 0-9, \*, #, Cancel, Backspace/Clear, and Enter keys
  - Dual-function Backspace/Clear key
  - Customer-entry for Cancel and Enter keys

**Back Functions** After removing the rear cover and battery, the underside of the V400m Plus 3G shows the following:



**Figure 2 V400m Underside**

- A **Micro SD** slot
- Dual **MSAM slots** to support stored-value card programs or other merchant card requirements
- Dual **SIM Card** compartments

## V400m Bases

The V400m Base provides a stable mounted platform for the V400m terminal. The Base comes in two versions:

- V400m Charging Base
- V400m Full-Function Base

The Charging Base supports charging only with no communication functionality. The Full-Function (FF) Base supports several connectivity options and provides serial connection for peripherals (like ECR, check reader, barcode reader, etc.). The USB host port is for maintenance purpose and supports a USB flash drive.

### V400m Charging Base

The Charging Base accommodates and supplies power to the V400m Plus 3G and V400m Plus 4G portable terminals.

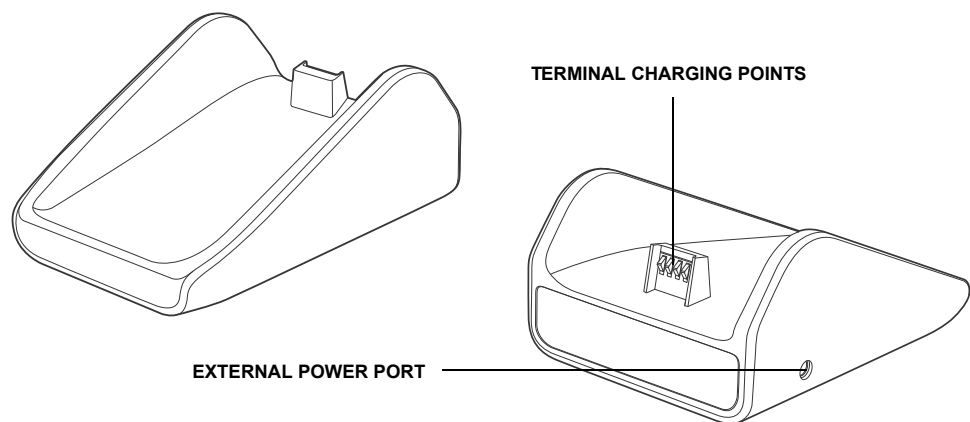

Figure 3 V400m Charging Base, Front and Rear

### V400m Full-Function Base

The FF Base supports any failover communication via dial up and Ethernet connections for V400m Plus 3G and V400m Plus 4G units. The failover will be supported in all network interfaces available in a terminal.

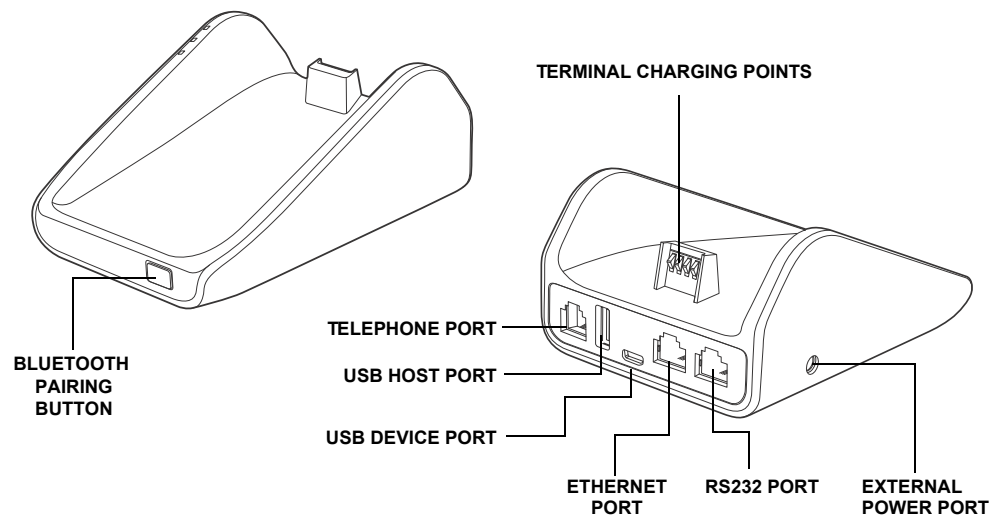

Figure 4 V400m FF Base, Front and Rear

The FF Base supports a maximum of seven simultaneous terminal connections via Bluetooth (BT) as well as the following:

- 10/100M Ethernet
- 56K modem
- WiFi
- Wireless 3G (HSPA) and 4G (LTE)
- USB host
- USB device

## Features and Benefits

The V400m terminal and Bases provide the following functionality:

### Exceptional Ease of Use and Ergonomics

- Touch screen enables easy menu control and signature capture.
- Battery-powered for mobility and portable operation.
- Integrated thermal printer for fast transaction processing.
- Large, hard-rubber keys provide improved tactile feedback.
- 3.5" capacitive touch screen display.
- 3G capability (for V400m Plus 3G only).
- 4G functionality (for V400m Plus 4G only).
- WiFi and Bluetooth-capable.
- Intuitive keypad interface simplify training and reduce support requests.
- Connects with most POS payment terminals, PCs and ECRs.
- Supports payment transactions in a variety of payment environments.
- Rugged and reliable design absorbs hard knocks found at point-of-sale counters.
- Sleek and stylish shape occupies minimal counter space.
- Bold, ergonomic design fits comfortably in the palm of a hand.
- Optional Charging or Full-Function Bases expand functionality while providing a stable, battery-charging platform.

**Critical Security Protection**

- Offers a choice of Master/Session or DUKPT key-management methods to protect PIN-based transactions.
- Offers secure, reliable PIN input for expanding range of PIN-based transactions.
- PCI 5.x-compliant for secure solutions, meeting the PED standard.
- Meets ISO and ANSI standards for PIN encryption, key management and MAC.
- Key injection simplified and secured with Verifone's SecureKit key loading software.



## Setup

This chapter describes the setup procedure for the V400m Terminal & Base in the following sections:

- Selecting Location
- PIN Protection Guidelines
- Unpacking Shipping Carton
- Installing MSAM, SIM and Micro SD Cards
- Loading Printer Paper
- Power Supply
- Cable Connections
- Smart Card Reader
- Magnetic Stripe Card Reader
- Contactless Transaction
- Optional Accessories
- Periodic Inspection

### Selecting Location

Use the following guidelines to select the best location for the V400m Terminal & Base device.

#### To Select a Location

Choose a location convenient for both merchant and client:

- Far from heavy metal objects
- A flat support surface such as a countertop or a table
- Near a power outlet and the terminal or computer that connects to the V400m Terminal & Base



For safety, do not string cables or cords across a walkway.

### Environmental Factors

- Do not use the unit where there is high heat, dust, humidity, moisture, or caustic chemicals or oils.
- Keep the unit away from direct sunlight and anything that radiates heat, such as a stove or a motor.

- Do not use the V400m Terminal & Base outdoors.



The V400m Terminal & Base is not waterproof or dustproof and is intended for indoor use only. Any damage to the unit from exposure to rain or dust can void any warranty.

### Electrical Considerations

- Avoid using this product during electrical storms.
- Do not use the V400m Terminal & Base unit near water or in moist conditions.
- Disconnect the device from its POS terminal before cleaning.



Due to the risk of electric shock or damage to the terminal, do not use this equipment near a water source, for example near a bathtub, washbowl, kitchen sink or laundry tub, in a wet basement or near a swimming pool. Likewise, avoid using this product during thunderstorms causing power cuts. Avoid placing the terminal near electrical devices or other units that could cause large voltage fluctuations or electrical interference, such as air conditioners, neon signs, high frequency safety devices or electrical equipment.

### Contactless Considerations

Avoid having metallic objects in proximity of the contactless antenna. If you need to mount the terminal to vertical or inclined surfaces, use a flat, non-metallic mounting plate.



Using an enclosed metal frame or mount may negatively affect contactless performance.

### PIN Protection Guidelines

The V400m Plus 3G and V400m Plus 4G are handover devices. Always exercise extreme caution when conducting transactions, especially during PIN entry:

- Hand the terminal directly to the cardholder for PIN entry.
- Encourage the cardholder to hold the terminal close to avoid others from seeing the information being entered.

Verifone also recommends instructing the cardholder regarding safe PIN-entry. This can be done with a combination of:

- Signage on the PED
- Prompts on the display, possibly with a click-through screen
- Literature at the point of sale
- A logo for safe PIN-entry process



## Unpacking Shipping Carton

Carefully inspect the shipping carton and its contents for possible tampering or damage.

- 1 Remove the V400m Terminal & Base unit from the shipping carton. The standard package contains the PIN pad, power pack, battery, and printer paper roll. Refer [Accessories and Documentation](#) to for more information about V400m Terminal & Base related accessories.



This device is a secure product and any tampering can cause it to cease to function or operate in an unsecured manner.

- 2 Remove any protective plastic wrap and place the unit on a table or countertop.
- 3 Remove the clear protective film from the display.
- 4 Replace all the packing materials, close the lid, and save the carton for repacking or moving the V400m Terminal & Base unit in the future.



Do not use a unit that has been tampered with or otherwise damaged. This unit comes equipped with tamper-evident label. If a label or component appears damaged, immediately notify the shipping company and your Verifone representative or service provider.

## Installing MSAM, SIM and Micro SD Cards

You may need to install or replace the multiple security access module (MSAM), Micro Secure Digital (SD) and Subscriber Identity Module (SIM) cards.



Observe standard precautions in handling electrostatically sensitive devices. Electrostatic discharges can damage the equipment. Verifone recommends using a grounded anti-static wrist strap.

## Accessing Card Compartments

Use the following procedure in order to access the cardholder compartment.

- 1 Place the terminal face down on a soft and clean surface to protect the lens from scratches.
- 2 Slide the compartment lock to the right and lift the compartment cover.

- 3 Remove the battery and place in a secure location.

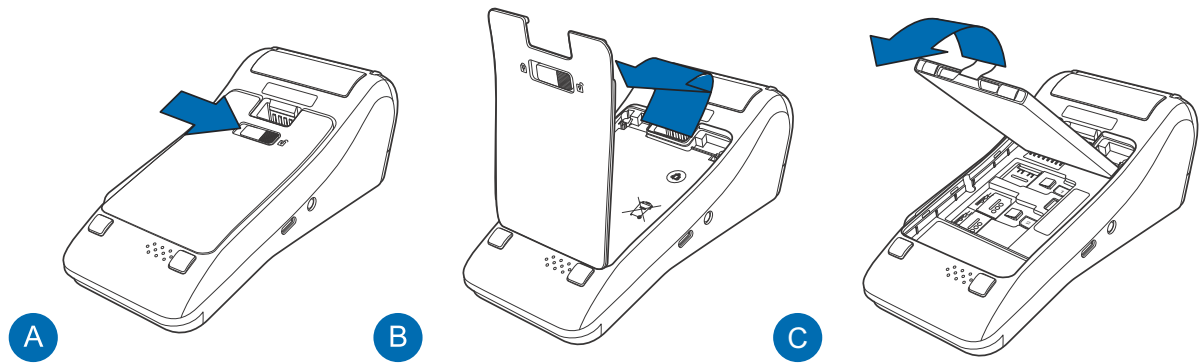

Figure 5 Accessing Cardholders



NOTE

Apart from using the pull tab to remove the battery from the compartment, you can also use the recessed areas on the lower portion of the battery to leverage the battery out.

- 4 The MSAM, SD and SIM cardholders are now accessible.

### Changing or Installing an MSAM Card

To change or install an MSAM card:

- 1 Follow steps 1 to 3 of [Accessing Card Compartments](#) to get to the MSAM cardholder.

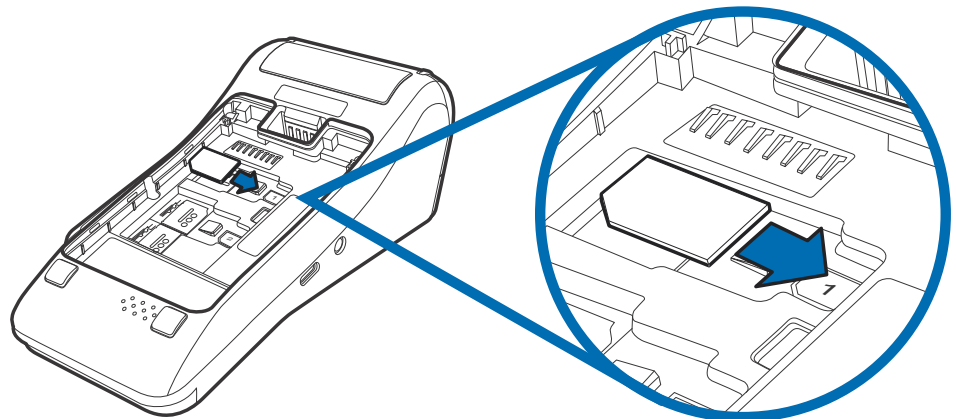

Figure 6 Inserting MSAM Card



NOTE

The V400m Terminal & Base supports two MSAM cards in a side-by-side configuration.

- 2 Push in the old MSAM card, if any, to release it from the slot.
- 3 Carefully insert the new MSAM card carefully into the slot facedown (with the gold contacts facing downward).

- 4 If you are finished replacing or inserting cards, replace the battery and terminal rear cover. Lock the cover by sliding the tab to the left.

### Changing or Installing a SIM Card

To change or install SIM cards:

- 1 Use steps 1 to 3 of [Accessing Card Compartments](#) to get to the SIM cardholder.

#### NOTE



The V400m supports two SIM cards in a side-by-side configuration.

- 2 Unlock the cardholder and swing upwards to allow the insertion or removal of cards.
- 3 Remove the old card, if any and install the SIM card by carefully sliding it into the slot (with the gold contacts facing outward) until fully inserted.

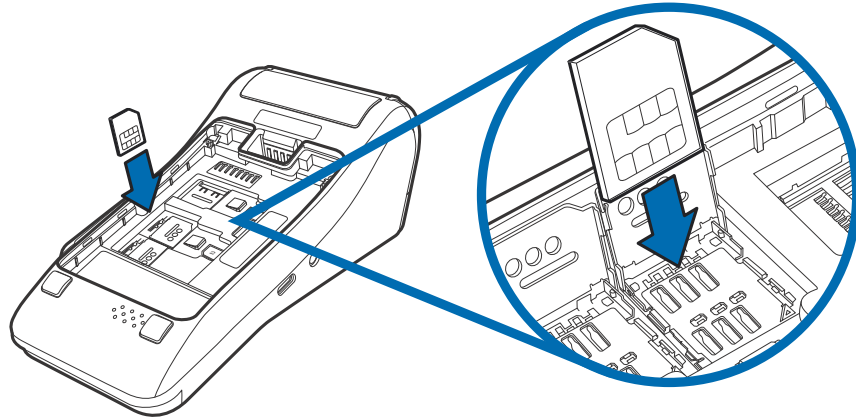

**Figure 7** Inserting SIM Card

- 4 Turn the cardholder back in place and slide the cover to lock the cardholder.
- 5 If you are finished replacing or inserting cards, replace the battery and terminal rear cover. Lock the cover by sliding the tab to the left.

## Changing or Installing a Micro SD Card

To change or install a Micro SD card:

- 1 Follow steps 1 to 3 of [Accessing Card Compartments](#) to get to the Micro SD cardholder.

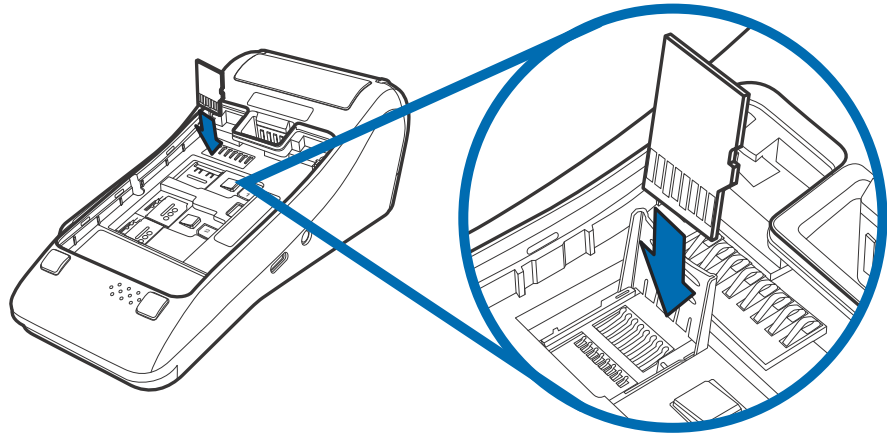

**Figure 8** Inserting Micro SD Card

- 2 Unlock the cardholder and turn upwards to allow the insertion or removal of cards.
- 3 Remove the old card, if any and insert the Micro SD card carefully into the cardholder (with the gold contacts facing outward) and turn the cardholder back in place.
- 4 Slide the cover to lock the cardholder closed.
- 5 If you are finished replacing or inserting cards, replace the battery and terminal rear cover. Lock the cover by sliding the tab to the left.

## Loading Printer Paper

Use the following steps to load a roll of 57 mm x 40 mm thermal printer paper into the compartment.

- 1 Unlock the paper compartment by pulling up the latch and swinging the door downwards.

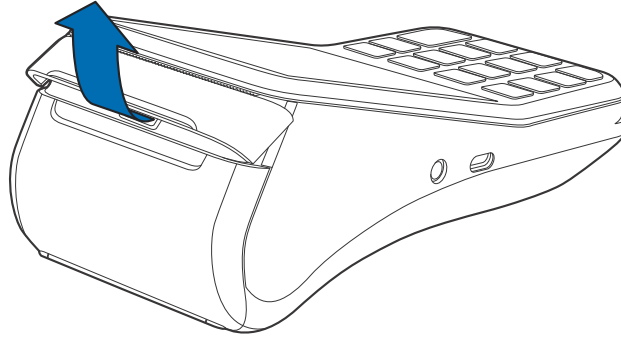

**Figure 9** Opening Printer Paper Door

- 2 Load the paper roll as shown in Figure 10, with the edge of the paper on the top of the roll.

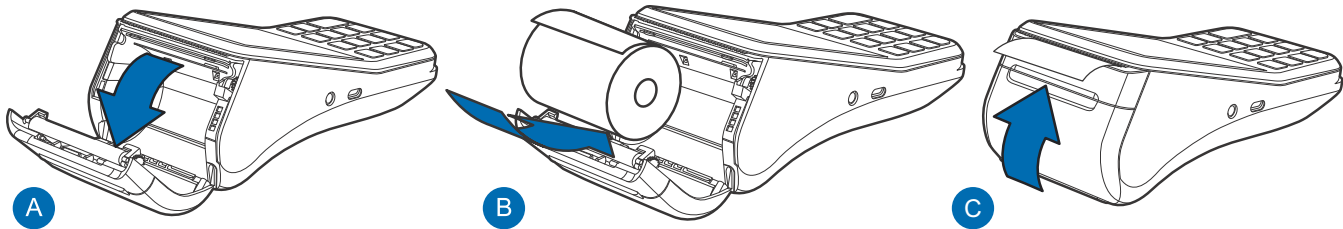

**Figure 10** Procedure for Loading Paper Roll

- 3 Pull a length of paper up over the serrated cutter and close the compartment door.



Before processing transactions in battery mode, make sure you have more than 10% battery life. Do not risk losing transaction data or printing capabilities, connect the terminal to the power pack if battery level is below 10%.

## Power Supply

Not all configurations and device contexts require the use of a power supply – Verifone ships power supply with the terminal as required.

Contact your Verifone representative if you have changed the context in which the terminal is used or have questions about which power supply should be used.



Using an incorrectly rated power supply can damage the unit or cause it not to work properly. Use only a power pack with VPN PWR475-010-01-A (see [Service and Support](#) for detailed power supply specifications).

Disconnect the power pack cord from the power outlet before connecting a power supply. Connect and route all cables between the terminal, ECR and PC before plugging the power pack cord into a wall outlet or surge protector.

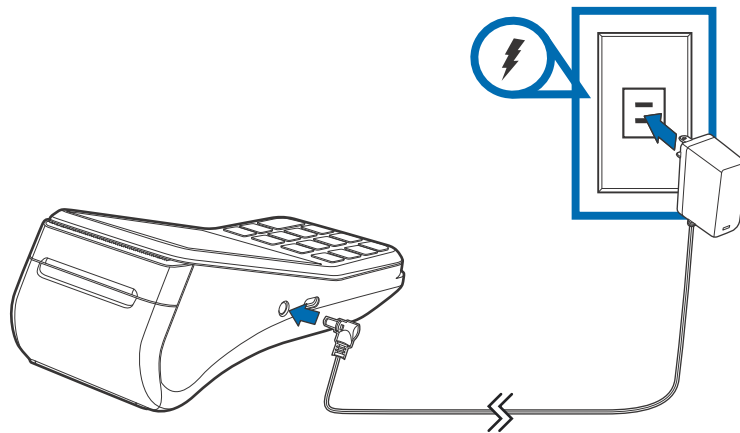

**Figure 11** Connecting the Power Pack



Do not plug the power pack into an outdoor outlet or operate the terminal outdoors. Disconnecting power during a transaction can cause transaction data files not yet stored in memory to be lost.



Verifone recommends installing a power surge protector to protect against possible damage caused by lightning strikes and electrical surges.

When the terminal has power and an application is loaded, the application starts after the initial Verifone copyright screen and displays a unique copyright screen. If no application is loaded, **DOWNLOAD NEEDED** appears on the display after the initial Verifone copyright screen.

## Cable Connections

The V400m Full-Function Base can utilize several types of cable connections.

### Cable Connections Using the FF Base

To connect the terminal to other devices via Ethernet, RS-232, and USB, use the V400m FF Base. The FF Base provides a standard RJ-45 LAN socket, RS-232 port, a mini-USB port. The V400m terminal must be docked on the base to utilize cable connectivity.

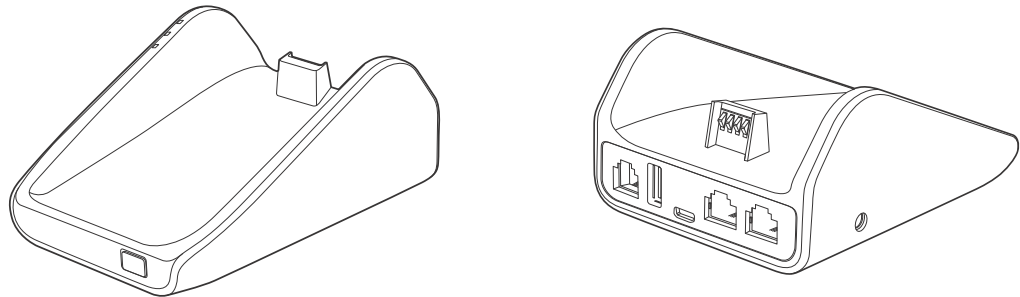

**Figure 12** FF Base, Front and Rear View

The FF Base features the following port configuration:

Cable	Configuration
Ethernet port	RJ-45 socket (for connecting PIN Pad to LAN infrastructure)
RS232 port	RS232 socket (for connecting PIN Pad to LAN infrastructure)
USB ports	Micro USB and type A USB

## Smart Card Reader

The smart card transaction procedure can vary depending on the application. Verify the proper procedure with your application provider before performing a smart card transaction.

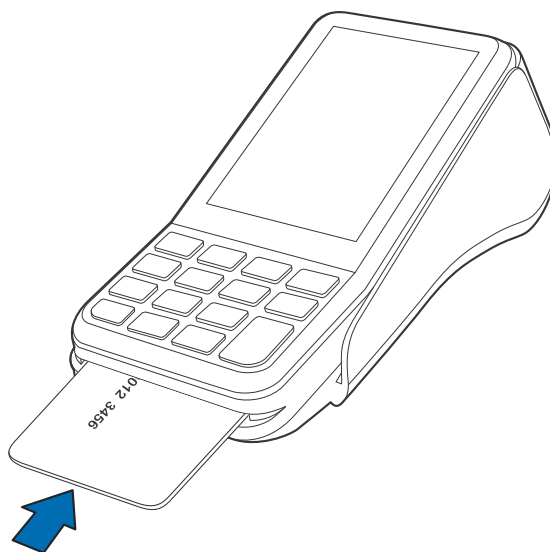

**Figure 13** Using the Smart Card Reader

**Conducting a Smart Card Transaction**

To conduct a smart card transaction:

- 1 Position the smart card with the gold contacts facing upward.
- 2 Insert the card into the smart card reader slot in a smooth, continuous motion until it seats firmly.
- 3 Remove the card when the display indicates the transaction is completed.



Leave the smart card in the card reader until the transaction is completed. Premature removal can void the transaction.

**Magnetic Stripe Card Reader**

The V400m has a magnetic card reader with a triple-track stripe reader. This gives the unit greater reliability over a wide range of swipe speeds and operating environments.

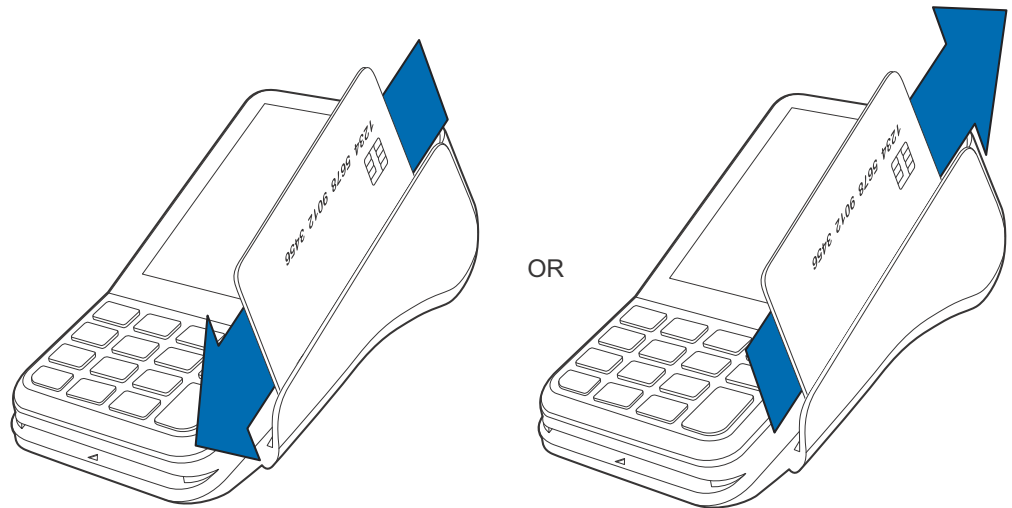

**Figure 14 Using the Magnetic Stripe Card Reader**

**Conducting a Credit/Debit Card Transaction**

To conduct a credit or debit card transaction:

- 1 Position a magnetic card with the stripe facing the keypad.
- 2 Swipe it through the magnetic card reader downwards or upwards. The reader can read the card from either direction.



## Contactless Transaction

The V400m supports contactless transactions through an integrated contactless module. The terminal only becomes active for contactless smart card transactions when initialized by an application.

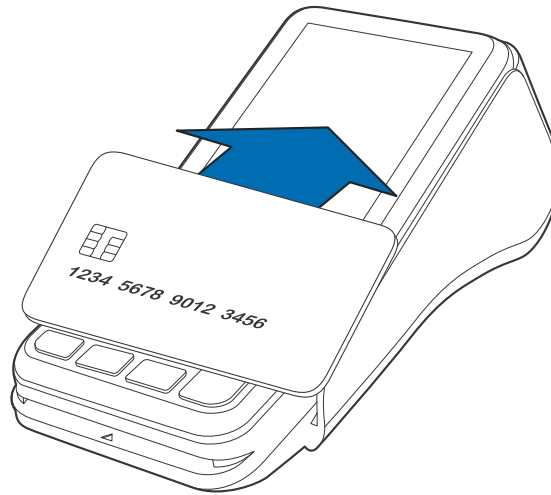

**Figure 15** Contactless Transaction

### *Performing Contactless Transaction*

To perform a contactless smart card transaction:

- 1 Gently tap the card onto or hold the card (within 4cm) against the surface of the display.
- 2 An activated LED visual on the display accompanied by a short beeping sound indicates a successful transaction.

## Optional Accessories

These accessories can be used to further enhance the device's functionality. See [Accessories and Documentation](#) for additional information.

**FF Base** The FF Base (VPN M475-S02-08) provides Bluetooth (BT) v4.2 as well as All BT v4.1 features. It also supplies power, Dial up, Ethernet, USB Host and USB Device, plus powered RS232 connection.

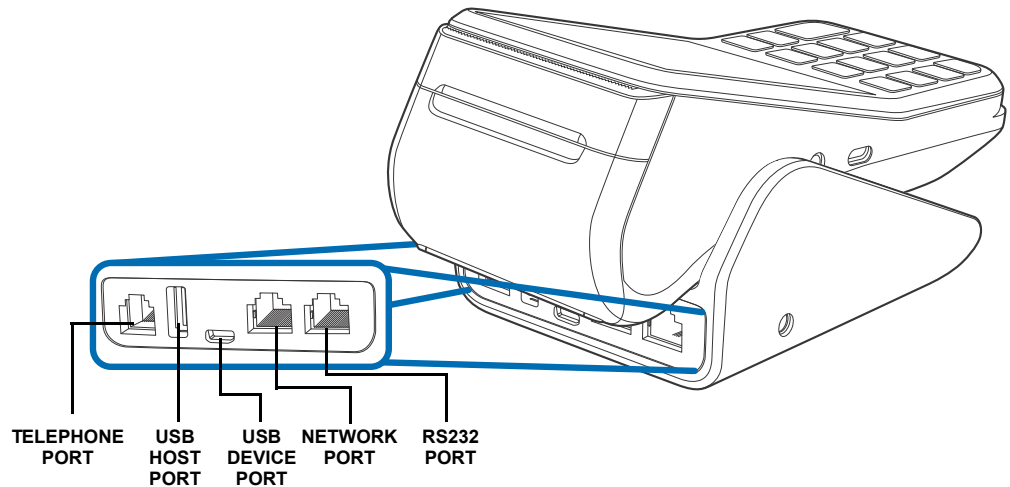

**Figure 16 V400m FF Base Connections**

**Charging Base** The Charging Base (VPN M475-S02-00) provides a stable dock plus power charging for the V400m Plus 3G terminal.

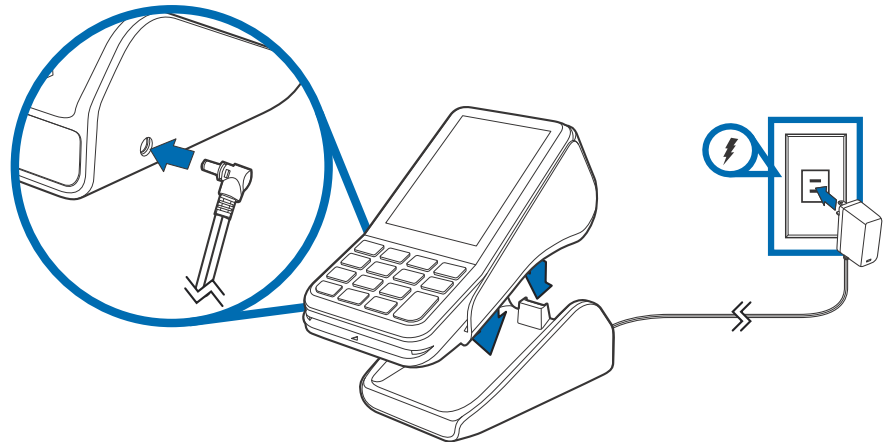

**Figure 17 V400m Charging Base Power Connection**

## Periodic Inspection

Periodically inspect the terminal and base for possible tampering. Signs of tampering may include:

- Wires protruding from the devices.
- Foreign objects inserted into the smart card or mag stripe slot.
- Signs of damage to the tamper-evident label.
- Warning message on the device display.

---

**NOTE**

If any device is found in tamper state, please remove it immediately from service. Keep it available for potential forensic investigation and notify your company security officer and your local Verifone representative or service provider. For more information on contacting Verifone, refer to [Service and Support](#).

---





## Specifications

This chapter discusses power requirements, dimensions and other specifications of the V400m Terminal & Base.

### V400m Terminal

Refer to the following specifications for the V400m terminal:

#### Unit Power Requirements

- Operating power: 5V DC, 2.2A

#### Temperature

- Operating temperature: 0° to 50°C (32° to 122°F)
- Storage temperature: -20° to 60°C (-4° to 140°F)

#### Humidity

- Relative humidity: 5% to 93% (RH non-condensing)

#### External Dimensions

	V400m	V400m Global 4G
Length	161 mm (6.34 in)	164 mm (6.46 in)
Width	72.75 mm (2.86 in)	72.75 mm (2.86 in)
Depth	56.85 mm (2.23 in)	56.85 mm (2.23 in)

#### Weight

	V400m	V400m Global 4G
Unit weight	370 g (13.05 oz)	372 g (13.12 oz)

#### Processor

- 32-bit ARM Cortex-A9 RISC Microprocessor
- 600 MHz clock speed

#### Memory

- 8 GB (LPDDR2: 4 GB, NAND Flash: 4GB)

**SD Memory**

- 4bit SDIO interface
- Up to 192 Mbit/sec (24 Mbyte/sec) in High-Speed SD mode 4bit data transfer
- Speed Class: SDHC Class 2, 4, 6 and 10

**Security**

- PCI 5.X Compliant

**Display**

- 3.5" transmissive amorphous TFT LCD TFT 320 (RGB) x 480 (HVGA)
- Independent 20X x 13Y sensing for real time touch point reporting
- Supports signature capture by finger or stylus (5 mm)
- I2C interface for touch controller command set

**SAM Card Reader**

- Primary SC reader and 2-SAMs
- Compatible with ISO7816-3, ISO7816-10 and EMV4.3 standards

**CTLS Reader**

- CTLS card operating in the RFID 13.56 MHz frequency band
- EMVCo, VISA, MasterCard and PBOC (qPBOC) approved

**Magnetic Card Reader**

- Triple track (tracks 1, 2, 3), high coercivity, bi-directional
- Swipe speed at 10 IPS to 40 IPS
- Supports Hi/Low coercivity cards

**Primary Smart Card**

- ISO 7816-3, 1.8V, 3V, 5V
- Synchronous and Asynchronous cards
- EMV Approved

**Speaker**

- Mono speaker and with an external CODEC (TI TLV320AIC3110)

## Communication

### Bluetooth

- BT class 1, 100 m range (line of sight)
- Supports BT v4.2

### WiFi

- Supports 2.4 GHz / 5 GHz frequency channels

### 3G Radio

- 3GPP Release 6,7
- HSPA DL 7.2 Mbps, UL 5.7 Mbps

### 4G Radio

- 3GPP Release 9
- LTE DL 10.2 Mbps, UL 5.2 Mbps

## Battery Pack

- Rating: 11.2 Wh (3.85V DC, 2890 mAh)
- Meets IEEE1725 requirements

## Power Pack

- Dual input charger to support charge through power pack or base station
- Supplied by an external universal-input 11 W power supply, compliant with Energy Star VI
- 5V, 2.2A Output
- 100-240V, 0.5A, 50-60 Hz Input

## Integrated Printer

- Printing voltage: 8 Volts
- Print Column Width: Option for printing 24/32/42 characters per line
- Supports 57 mm W x 40 mm D paper roll

## Security

- 3DES encryption, Master/Session and DUKPT key management
- VeriShield file authentication
- PCI PED 5.X approved

## V400m Bases

### Charging Base

- Provides terminal charging on a mounted stand

### Full-Feature Base

- Apart from charging, the FF Base provides:
  - 10/100M Ethernet
  - 56K modem
  - LE Secure feature of BT v4.2 + All BT v4.1 feature
  - USB host
  - USB device

### Unit Power Requirements

- Operating power: 5V DC, 2.2A

### Temperature

- Operating temperature: 0° to 50°C (32° to 122°F)
- Storage temperature: -20° to 60°C (-4° to 140°F)

### Humidity

- Relative humidity: 5% to 95% (RH non-condensing)

### Communication

- 10/100M Ethernet
- 56K modem
- LE Secure feature of BT v4.2 + All BT v4.1 feature
- USB host
- USB device

### Security

- PCI 5.X Compliant





## Troubleshooting Guidelines

This chapter lists typical malfunctions that may occur while operating a V400m terminal or V400m Base and the appropriate corrective action. If the problem persists – even after performing the outlined guidelines, or if the problem is not described, contact your local Verifone representative for assistance.

**NOTE**

The V400m terminal and V400m Base use a tamper-evident case and contains no user-serviceable parts. Do not, under any circumstance, attempt to disassemble the unit. Perform only those adjustments or repairs specified in this guide. For all other services, contact your local Verifone service provider. Service conducted by parties other than authorized Verifone representatives may void any warranty.

### Display Panel Does Not Work

Use the following steps to check the display panel:

- 1 Check all the cable connections.
- 2 Check the device's AC outlet to be sure the outlet is supplying sufficient power. Substitute the device's power pack with another power pack.
- 3 The device's application program might not be loaded correctly. Download the application program and try again.
- 4 If the problem persists, contact your local Verifone representative.

### Keypad Does Not Respond

Use the following steps to check the keypad:

- 1 Check the display panel. If there are no characters, or the wrong characters are displayed, refer to [Display Panel Does Not Work](#).
- 2 If the problem persists, contact your local Verifone representative.

### Transactions Fail to Process

There are several possible reasons why the unit may not be processing transactions. Use the following steps to troubleshoot failures.

#### Check Magnetic Card Reader

- Perform a test transaction using one or more different magnetic stripe cards to ensure the problem is not a defective card.
- Ensure that you are swiping cards properly (see [Magnetic Stripe Card Reader](#)).
- Process a transaction manually using the keypad instead of the card reader. If the manual transaction works, the problem may be a defective card reader.
- If the problem persists, contact your local Verifone representative.

### **Check Smart Card Reader**

- Perform a test transaction using several different smart cards to ensure the problem is not a defective card.
- Ensure that the card is inserted correctly (see [Magnetic Stripe Card Reader](#)).
- Ensure the MSAM cards are properly inserted in the slots and are properly secured (see [Installing MSAM, SIM and Micro SD Cards](#)).
- If the problem persists, contact your local Verifone representative.



## Service and Support

### Maintenance and Cleaning

The V400m Terminal & Base have no user-serviceable parts. Unless otherwise instructed, do not, under any circumstances, attempt any service, adjustments, or repairs on the unit. Disconnect power to the devices before cleaning.

To clean the units, periodically use a clean cloth, slightly dampened with water and a drop or two of mild soap. For stubborn stains, use alcohol or an alcohol-based cleaner. For best results, use a Verifone Cleaning Kit (refer to [Accessories and Documentation](#)).



CAUTION

Never use thinner, trichloroethylene, or ketone-based solvents – they can deteriorate plastic or rubber parts.

Because the V400m Terminal & Base can be damaged by liquid, do not spray cleaners or other solutions directly onto the keypad or display. Always apply the cleaner to a cloth before cleaning the device.

### Service Returns

For V400m Terminal & Base equipment failures that cannot be resolved by your help desk or service department, contact one of the following hotlines for product service and repair information:

- USA – Verifone Service and Support Group, 1-800-834-9133, Monday - Friday, 8 A.M. - 7 P.M., EST
- International – Contact your Verifone representative

Before returning V400m Terminal & Base to Verifone, you must obtain a Merchandise Return Authorization (MRA) number. The following procedure describes how to return one or more V400m Terminal & Base for repair or replacement (U.S. customers only).

NOTE



International customers, please contact your local Verifone representative for assistance with your service, return, or replacement.

**1** Gather the following information from the printed labels on the bottom of *each* V400m Terminal & Base device to be returned:

- Product ID, including the model and part number. For example, “M180-08x-xx-xxx-x”

- Serial number (S/N xxx-xxx-xxx)

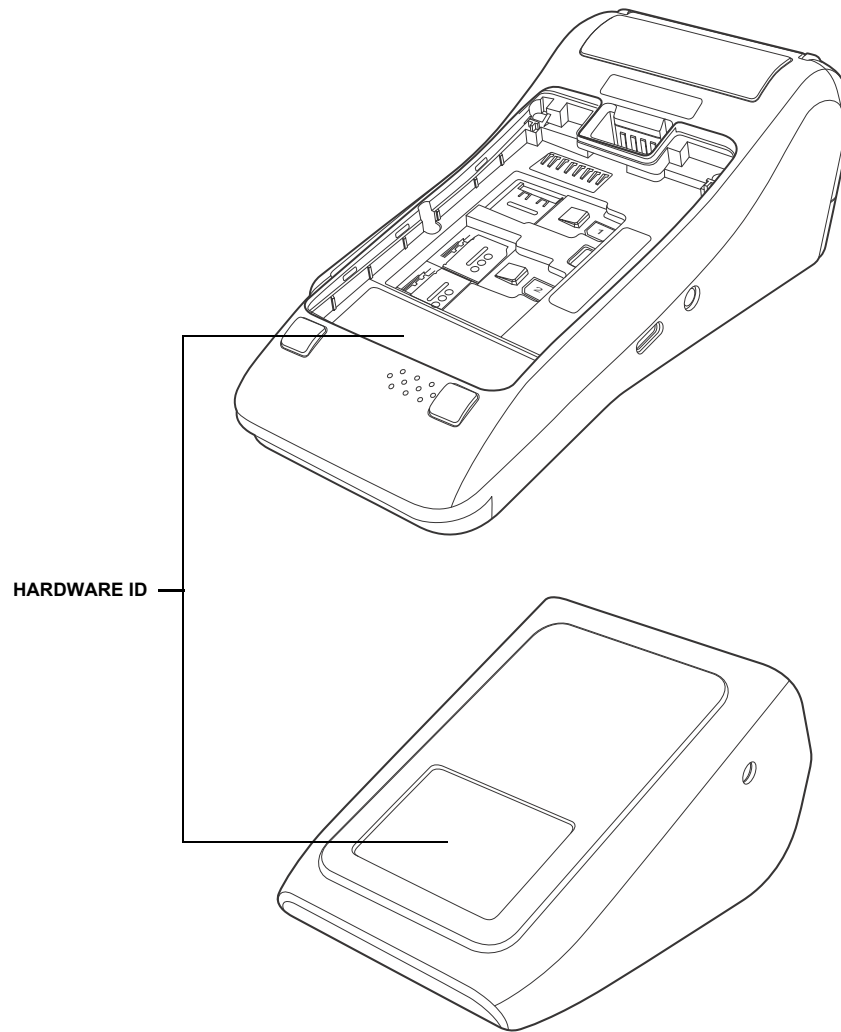

**Figure 18 Finding the Product ID and Serial Number**

- 2** Within the United States, call Verifone toll-free at 1-800-834-9133.
- 3** Select the MRA option from the automated message. The MRA department is open Monday–Friday, 8 A.M.–7 P.M., EST.
- 4** Give the MRA representative the information gathered in [Step 1](#).  
If the list of serial numbers is long, you can fax the list, along with the information gathered in [Step 1](#), to the MRA department at 1-727-953-4172 (U.S.).
  - Please address the fax clearly to the attention of the “Verifone MRA Dept.”
  - Include a telephone number where you can be reached, as well as your fax number.

- You will be issued MRA number(s) and the fax will be returned to you.



One MRA number must be issued for each V400m Terminal & Base unit you return to Verifone, even if you are returning several of the same model.

- 5 Describe the problem(s).
- 6 Provide the shipping address where the repaired or replacement unit must be returned.
- 7 Keep a record of the following items:
  - Assigned MRA number(s).
  - The serial number assigned to the V400m Terminal & Base device (located at the bottom of the unit).
  - Shipping documentation, such as air bill numbers, used to trace the shipment.
  - Model(s) returned (model numbers are located on the bottom of the unit).

## Accessories and Documentation

Verifone produces accessories and documentation for the V400m Terminal & Base. When ordering, please refer to the part number in the left column.

- Verifone Online Store at [www.estore.verifone.com](http://www.estore.verifone.com)
- USA – Verifone Customer Development Center, 1-800-Verifone (837-4366) Monday - Friday, 7 A.M. - 5 P.M., MST
- International – Contact your Verifone representative

**Cables** Contact your local Verifone distributor to determine which cable fits your needs.

CBL282-036-XX-A	RS-232 cable (RJ45). Powered from Countertop (+12V)
CBL282-006-01-B	Cable, VX 820 Ethernet/RS232, Dongle 1.0 M
CBL435-005-02-A	Ethernet and Mini-USB Dongle
CBL435-044-01-A	Cable, USB/Ethernet/RS232, Dongle 1.0 M

### **Base**

M475-S02-00	V400m B Charging Base
M475-S02-08	V400m B Full-Function (FF) Base

### **Power Supply**

PWR475-010-01-A	DC power pack (US)
BPK475-001-01-A	Battery Pack (11.2 Wh, 3.85V DC, 2890 mAh)

### **Cleaning Kit**

02746-01	Verifone Cleaning Kit
----------	-----------------------

**Documentation**

DOC475-001-EN	V400m Plus 3G Certifications and Regulations
DOC475-002-EN	V400m Quick Installation Guide
DOC475-004-EN	V400m Reference Guide
DOC475-006-EN	V400m B-Charging Quick Installation Guide
DOC475-007-EN	V400m B-FF Quick Installation Guide
DOC475-011-EN	V400m Base C and FF Certifications & Regulations Sheet
DOC475-031-EN	V400m Plus 4G Certifications and Regulations



## Caution and Warning Messages

Products with UL/cUL certification should include French translations of Caution and Warning notices. The following table lists all notices found in the document, their location and the equivalent French translations.

**Table 3 Caution and Warning Messages**

Notice	Chapter	Page	English Text	French Text
Warning	Setup	page 15	For safety, do not string cables or cords across a walkway.	<i>Par mesure de sécurité, ne pas les câbles de chaîne ou de cordons à travers une passerelle.</i>
Caution	Setup	page 16	This unit is not waterproof or dustproof and is intended for indoor use only. Any damage to the unit from exposure to rain or dust can void any warranty.	<i>Cet appareil n'est pas étanche ou à la poussière, et est destiné à une utilisation en intérieur. Tout dommage à l'unité de l'exposition à la pluie ou à la poussière peut annuler la garantie.</i>
Caution	Setup	page 16	Using an enclosed metal frame or mount may negatively affect contactless performance.	<i>L'utilisation d'un cadre métallique fermé ou de montage peut affecter négativement contact performance.</i>
Warning	Setup	page 16	Due to the risk of electric shock or damage to the terminal, do not use this equipment near a water source, for example near a bathtub, washbowl, kitchen sink or laundry tub, in a wet basement or near a swimming pool. Likewise, avoid using this product during thunderstorms causing power cuts. Avoid placing the terminal near electrical devices or other units that could cause large voltage fluctuations or electrical interference, such as air conditioners, neon signs, high frequency safety devices or electrical equipment.	<i>Du fait d'un risque d'électrocution ou d'une détérioration du terminal, ne pas utiliser cet équipement près d'une source d'eau, par exemple près d'une baignoire, d'un lavabo, d'un évier de cuisine ou d'un bac de lavage, dans un sous-sol humide ou à proximité d'une piscine. De même, éviter d'utiliser ce produit lors des orages provoquant des coupures électriques. Éviter de placer le terminal à proximité d'appareils électriques ou autres unités pouvant entraîner des fluctuations de tension importantes ou des interférences électriques, tels que les climatiseurs, enseignes au néon, dispositifs de sécurité à haute fréquence ou équipements électriques.</i>
Caution	Setup	page 17	This device is a secure product and any tampering can cause it to cease to function or operate in an unsecured manner.	<i>Cet appareil est un produit sûr et toute manipulation peut l'amener à cesser de fonctionner ou fonctionner de manière non sécurisée.</i>

**Table 3** Caution and Warning Messages (continued)

Notice	Chapter	Page	English Text	French Text
Warning	Setup	page 17	Do not use a unit that has been tampered with or otherwise damaged. This unit comes equipped with tamper-evident label. If a label or component appears damaged, immediately notify the shipping company and your Verifone representative or service provider.	<i>Ne pas utiliser un appareil qui a été altéré ou endommagé. Cet appareil est équipé d'étiquette d'inviolabilité. Si une étiquette ou d'un composant semble être endommagé, en aviser immédiatement la compagnie maritime et votre représentant Verifone ou prestataire de services.</i>
Caution	Setup	page 17	Observe standard precautions in handling electrostatically sensitive devices. Electrostatic discharges can damage the equipment. Verifone recommends using a grounded anti-static wrist strap.	<i>Respecter les précautions standard dans la manipulation d'appareils sensibles aux décharges électrostatiques. Les décharges électrostatiques peuvent endommager le matériel. Verifone recommande d'utiliser un bracelet anti-statique à la terre.</i>
Caution	Setup	page 22	Before processing transactions in battery mode, make sure you have more than 10% battery life. Do not risk losing transaction data or printing capabilities, connect the terminal to the power pack if battery level is below 10%.	<i>Avant de traiter les transactions en mode batterie, assurez-vous d'avoir plus de 10% de la durée de vie de la batterie. Ne risque pas de perdre les données de transaction ou les capacités d'impression, connectez le terminal au bloc d'alimentation si le niveau de la batterie est inférieur à 10%.</i>
Caution	Setup	page 22	Using an incorrectly rated power supply can damage the unit or cause it not to work properly. Use only a power pack with VPN PWR435-001-01-A.	<i>L'utilisation d'une alimentation incorrecte peut endommager l'appareil ou ne pas fonctionner correctement. Utilisez uniquement un bloc d'alimentation avec VPN PWR435-001-01-A.</i>
Caution	Setup	page 22	Do not plug the power pack into an outdoor outlet or operate the terminal outdoors. Disconnecting power during a transaction can cause transaction data files not yet stored in memory to be lost.	<i>Ne branchez pas le bloc d'alimentation dans une prise extérieure ou n'utilisez pas le terminal à l'extérieur. La déconnexion de l'alimentation pendant une transaction peut entraîner la perte des fichiers de données de transaction qui ne sont pas encore stockés dans la mémoire.</i>



**Table 3** Caution and Warning Messages (continued)

Notice	Chapter	Page	English Text	French Text
Caution	Setup	page 24	Leave the smart card in the card reader until the transaction is completed. Premature removal can void the transaction.	<i>Laissez la carte à puce dans le lecteur de carte jusqu'à ce que la transaction soit terminée. Le retrait prématuré peut annuler la transaction.</i>
Caution	Service and Support	page 35	Never use thinner, trichloroethylene, or ketone-based solvents – they can deteriorate plastic or rubber parts. Because this device can be damaged by liquid, do not spray cleaners or other solutions directly onto the keypad or display. Always apply the cleaner to a cloth before cleaning the device.	<i>N'utilisez jamais de diluant, le trichloréthylène ou des solvants cétoniques - ils peuvent détériorer les pièces en plastique ou en caoutchouc. Parce que cet appareil peut être endommagé par un liquide, ne pas vaporiser de nettoyage ou d'autres solutions directement sur le clavier ou l'écran. Toujours appliquer le nettoyant sur un chiffon avant de nettoyer l'appareil.</i>





Verifone, Inc.  
1-800-Verifone  
[www.verifone.com](http://www.verifone.com)

# V400m Terminal & Base

## *Installation Guide*

